

**3500 SINGLE HUNG WINDOW (9109)**  
Vertical Section - DP50 upgrade

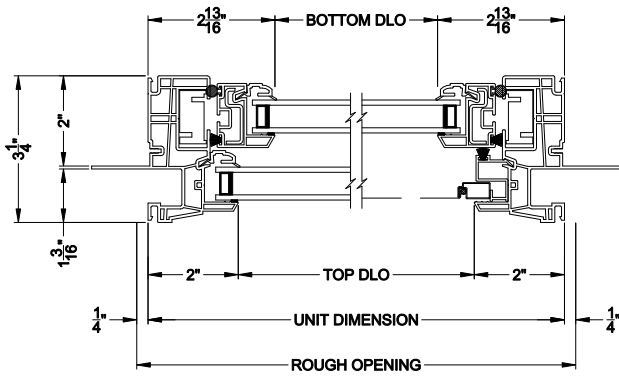

**3500 SINGLE HUNG WINDOW (9109)**  
Horizontal Section - DP50 upgrade

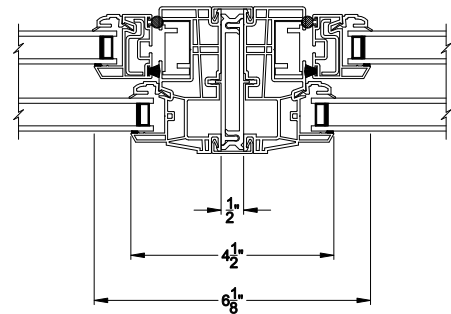

**3500 SINGLE HUNG WINDOW**  
Aluminum Vertical Mull Section - SH / SH

Note: All dimensions are approximate. Visions reserves the right to change specifications without notice.